

Communicative globe valve actuator for 2-way and 3-way globe valves

- Actuating force 1000 N
- Nominal voltage AC/DC 24 V
- Nominal stroke 20 mm
- Integrated temperature controller
- Communication via LONWORKS® (FTT-10A)
- Conversion of sensor signals

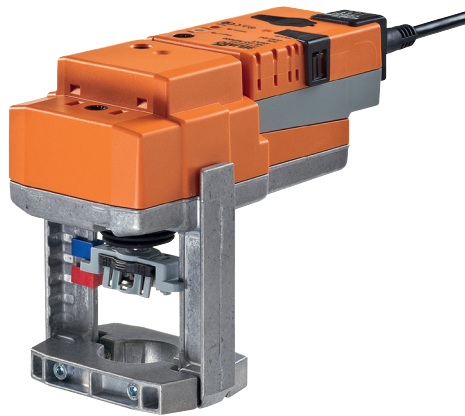

LONMARK®

Technical data

Electrical data	Nominal voltage	AC/DC 24 V
	Nominal voltage frequency	50/60 Hz
	Nominal voltage range	AC 19.2...28.8 V / DC 21.6...28.8 V
	Power consumption in operation	1.5 W
	Power consumption in rest position	0.5 W
	Power consumption for wire sizing	3 VA
	Connection supply / control	Cable 1 m, 6 x 0.75 mm ²
Data bus communication	Certified	According to LONMARK® 3.3
	Processor	Neuron 3150
	Transceiver	FTT-10A
	Functional Profile as per LONMARK®	Damper Actuator Object #8110 Open Loop Sensor Object #1 Thermostat Object #8060
	LNS plug-in for actuator / sensor / controller	Can be run with any LNS-based integration tool (Min. for LNS 3.x)
	Service button and status LED	According to LONMARK® guidelines
	Conductors, cables	Signal cable lengths, cable specifications and topology of the LONWORKS® network in accordance with the ECHELON® guidelines
Functional data	Actuating force motor	1000 N
	Position feedback U	DC 2...10 V
	Position feedback U note	Max. 0.5 mA
	Position feedback U variable	Start point DC 0.5...8 V End point DC 2.5...10 V
	Position accuracy	5% absolute
	Manual override	With push-button, can be locked
	Nominal stroke	20 mm
	Actuating time motor	150 s / 20 mm
	Actuating time variable	90...150 s / 20 mm
	Adaption setting range	manual (automatic on first power-up)
	Override control, controllable via nviManOvrd	MAX (maximum position) = 100% MIN (minimum position) = 0% ZS (intermediate position) = 50%
	Sound power level motor	45 dB(A)
	Position indication	Mechanically, 5...20 mm stroke
	Safety	Protection class IEC/EN
Protection class UL		UL Class 2 Supply
Degree of protection IEC/EN		IP54
Degree of protection NEMA/UL		NEMA 2, UL Enclosure Type 2
EMC		CE according to 2014/30/EU
Certification IEC/EN		IEC/EN 60730-1 and IEC/EN 60730-2-14
Certification UL		cULus according to UL 60730-1A, UL 60730-2-14 and CAN/CSA E60730-1:02
Mode of operation		Type 1
Rated impulse voltage supply / control		0.8 kV
Control pollution degree		3
Ambient temperature range	0...50°C	
Non-operating temperature	-40...80°C	
Ambient humidity	95% r.h., non-condensing	

Technical data

Safety	Maintenance	Maintenance-free
Weight	Weight	1.5 kg

Safety notes



- This device has been designed for use in stationary heating, ventilation and air conditioning systems and must not be used outside the specified field of application, especially in aircraft or in any other airborne means of transport.
- Only authorised specialists may carry out installation. All applicable legal or institutional installation regulations must be complied during installation.
- The switch for changing the direction of motion and so the closing point may be adjusted only by authorised specialists. The direction of motion is critical, particularly in connection with frost protection circuits.
- The device may only be opened at the manufacturer's site. It does not contain any parts that can be replaced or repaired by the user.
- Cables must not be removed from the device.
- The device contains electrical and electronic components and must not be disposed of as household refuse. All locally valid regulations and requirements must be observed.

Product features

Mode of operation	The actuator is equipped with an integrated interface for LONWORKS®. The actuator can be directly connected to the LON network and controlled via the transceiver FTT-10A
Converter for sensors	Connection option for a sensor (passive or active sensor or switching contact). In this way, the analogue sensor signal can be easily digitised and passed along to LONWORKS®.
Integrated temperature controller	The device has an integrated temperature controller (Thermostat Object LONMARK® #8060). Other control variants upon request. The temperature controller can be set using the LNS Plug-In from Belimo.
Parameterisable actuators	The factory settings cover the most common applications. Single parameters can be modified with the Belimo Service Tools MFT-P or ZTH EU.
Simple direct mounting	Simple direct mounting on the globe valve by means of form-fit hollow clamping jaws. The actuator can be rotated by 360° on the valve neck.
Manual override	Manual override with push-button possible (the gear is disengaged for as long as the button is pressed or remains locked). The stroke can be adjusted by using a hexagon socket screw key (4 mm), which is inserted into the top of the actuator. The stroke spindle extends when the key is rotated clockwise.
High functional reliability	The actuator is overload protected, requires no limit switches and automatically stops when the end stop is reached.
Combination valve/actuator	Refer to the valve documentation for suitable valves, their permitted medium temperatures and closing pressures.
Position indication	The stroke is indicated mechanically on the bracket with tabs. The stroke range adjusts itself automatically during operation.
Home position	Factory setting: Actuator spindle is retracted. When valve-actuator combinations are shipped, the direction of motion is set in accordance with the closing point of the valve. The first time the supply voltage is switched on, i.e. at the time of commissioning, the actuator carries out an adaption, which is when the operating range and position feedback adjust themselves to the mechanical setting range. The actuator then moves into the position defined by the positioning signal.
Direction of stroke switch	When actuated, the direction of stroke switch changes the running direction in normal operation.

Product features

Adaption and synchronisation An adaption can be triggered manually by pressing the “Adaption” button or with the PC-Tool. Both mechanical end stops are detected during the adaption (entire setting range).
Automatic synchronisation after pressing the gearbox disengagement button is configured. The synchronisation is in the home position (0%).
The actuator then moves into the position defined by the positioning signal.
A range of settings can be adapted using the PC-Tool (see MFT-P documentation)

Accessories

	Description	Type
Electrical accessories	Connecting cable 5 m, A+B: RJ12 6/6, To ZTH/ZIP-USB-MP	ZK1-GEN
	Connection cable 5 m, A: RJ11 6/4, B: Free wire end, To ZTH/ZIP-USB-MP	ZK2-GEN
Service Tools	Description	Type
	Service Tool, for MF/MP/Modbus/LonWorks actuators and VAV-Controller	ZTH EU
	Belimo PC-Tool, software for adjustments and diagnostics	MFT-P
	Adapter to Service Tool ZTH	MFT-C

Electrical installation

Notes

- Connection via safety isolating transformer.
- Direction of stroke switch factory setting: Actuator spindle retracted.

Wiring diagrams

Connection without sensor

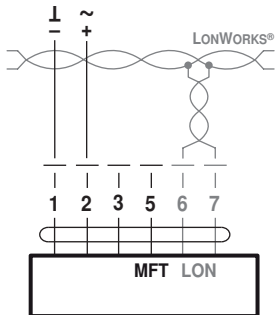

Connection with passive sensor, e.g. Pt1000, Ni1000, NTC

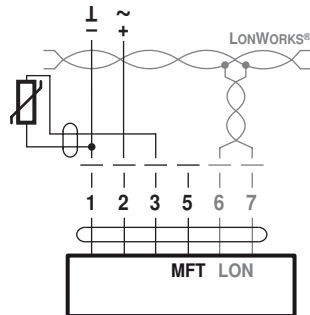

Ni1000	-28...+98°C	850...1600 Ω ²⁾
PT1000	-35...+155°C	850...1600 Ω ²⁾
NTC	-10...+160°C ¹⁾	200 Ω...60 kΩ ²⁾

Sensor scaling:
The sensors can be scaled with the sensor plug-in (sensor table).
1) Depending on type
2) Resolution 1 Ohm

Connection with active sensor, e.g. 0...10 V @ 0...50°C

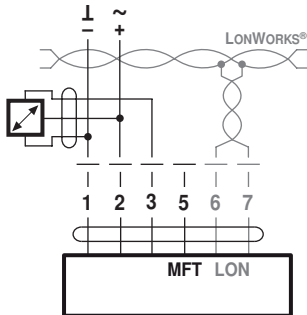

Possible voltage range:
0...32V (Resolution 30 mV)
Sensor scaling:
The sensors can be scaled with the sensor plug-in (sensor table)

Connection with switching contact, e.g. Δp monitor

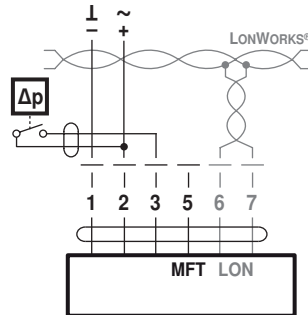

Switching contact requirements:
The switching contact must be able to switch a current of 16 mA at 24 V accurately.

Functional Profile as per LONMARK®

The LON-capable actuator is certified by LONMARK®. The following actuator functions are made available via the LONWORKS® network as standardised network variables in accordance with LONMARK®: the Node Object #0, the Damper Actuator Object #8110, the Open Loop Sensor Object #1 and the Thermostat Object #8060.

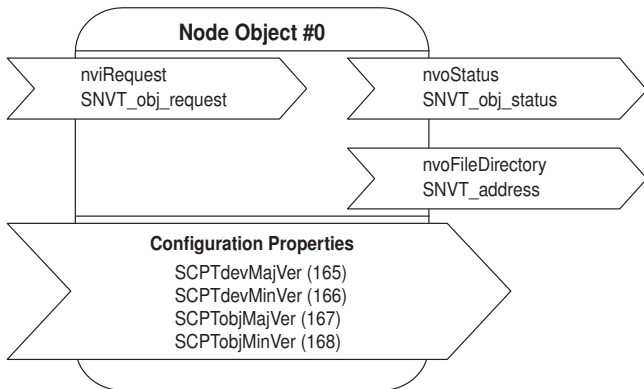

Node Object #0

The node object contains the object status and object request functions.

nviRequest: SNVT_obj_request

Input variable for requesting the status of a particular object in the node.

nvoStatus: SNVT_obj_status

Output variable that outputs the current status of a particular object in the node.

nvoFileDirectory: SNVT_address

Output variable that shows information in the address range of the Neuron chip.

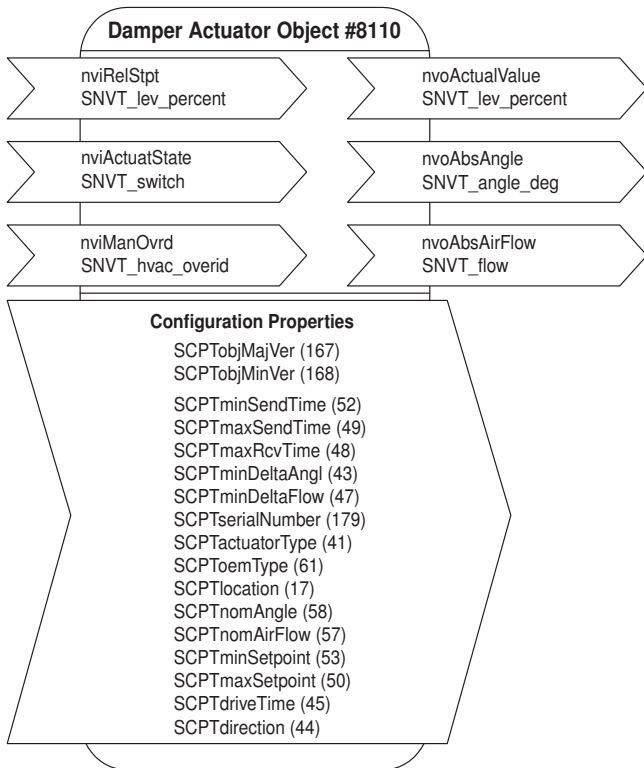

Damper Actuator Object #8110

The actuator object is used to display the functions of the actuator on the page of the LONWORKS® network.

nviRelStpt: SNVT_lev_percent

Via this input variable, the setpoint in % for the actuator is specified (0...100% = Min...Max). This variable is normally linked to the output variable of an HVAC controller.

nviActuateState: SNVT_switch

A preset position is assigned to the actuator via this input variable. Note on priority: The variable which was most recently active, either nviActuatorState or nviRelStpt, has priority.

nviManOvrd: SNVT_hvac_overid

see table «Override control with SNVT nviManOvrd»

nvoActualValue: SNVT_lev_percent

This output variable shows the current actual position of the actuator and can be used for control circuit feedback or for displaying positions.

nvoAbsAngle: SNVT_angle_deg

This output variable shows the current angle of rotation / stroke of the actuator and can be used to display the position or for service purposes.

nvoAbsAirFlow: SNVT_flow

This output variable is inactive with this actuator and shows a constant value of 65535 (this variable is only active in conjunction with LON-capable VAV controllers).

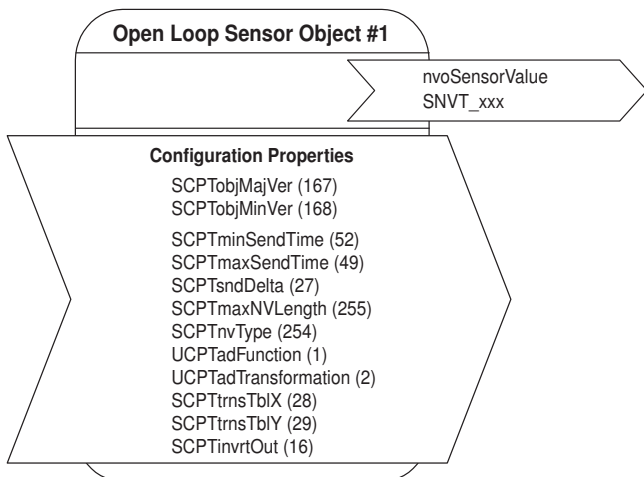

Open Loop Sensor Object #1

One sensor can be connected to the actuator.

A passive resistance sensor (e.g. Ni1000), an active sensor (output 0...32 V) or a switch (On/Off) can be connected. In the case of the open loop sensor object, the measured sensor values are transferred to the LONWORKS® network.

nvoSensorValue: SNVT_XXX

This output variable shows the current sensor value. Depending on the connected sensor, the output variable can be configured via the sensor plug-in and specifically adapted to the system.

The SNVT .. can be configured as:

SNVT_temp_p	SNVT_lev_percent	SNVT_lux
SNVT_temp	SNVT_abs_humid	SNVT_press_p
SNVT_switch	SNVT_enthalpy	SNVT_smo_obscur
SNVT_flow	SNVT_ppm	SNVT_power
SNVT_flow_p	SNVT_rpm	SNVT_elec_kwh

Functional Profile as per LONMARK®

Individual room control solutions can be implemented with the thermostat object LONMARK® #8060. An LNS plug-in is available for configuring the controller parameters.

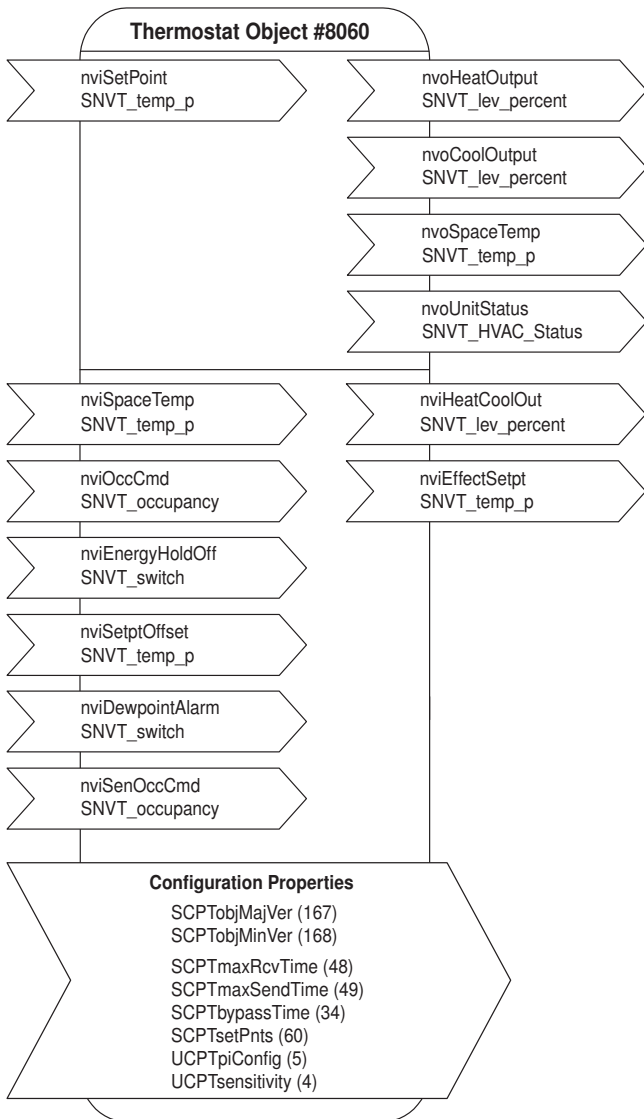

Note
A restart is necessary after accessing network variables for the purpose of rewriting them or after deleting links in order to initialise the variables.

Thermostat Object #8060

nviSetPoint: SNVT_temp_p

Setpoint specification for the controller from the higher-level system or the room control unit. If this variable is not linked, then the local setpoints of the controller object apply (can be adjusted via plug-in). The setpoint specification from the higher-level system influences the setting on the controller as follows:

Example: Comfort setpoint for heating = 21 °C and Comfort setpoint for cooling = 23 °C. The median point between heating and cooling is thus 22 °C. Now, if the external setpoint (nviSetPoint) is 23 °C, then the heating setpoint will shift to 22 °C and the cooling set point to 24 °C. The setpoints for Pre-Comfort heating and cooling will also be shifted accordingly.

nviSpaceTemp: SNVT_temp_p

Room temperature from external room sensor. It is imperative that this variable be linked; typically, it is linked with the variable of the sensor object.

nviOccCmd: SNVT_occupancy

Occupancy specification from the command centre (for the function, see the table entitled «Functions Inputs Occupancy» next page).

nviEnergyHoldOff: SNVT_switch

In the case of active EnergyHoldOff, the controller will be set to the Building Protection setpoints.

nviSetPtOffset: SNVT_temp_p

Shifting of the room control unit. If the nviSetPoint is linked, then this input has an influence on the variable value of nviSetPoint, i.e. it corrects it. Otherwise, the Comfort and Pre-Comfort setpoints for heating and cooling will be adjusted directly by the amount of the shift (compare example with nviSetPoint).

nviDewpointAlarm: SNVT_switch

In the case of active DewpointAlarm, the controller will be set to the Building Protection setpoints. The cooling sequence is deactivated.

nviSenOccCmd: SNVT_occupancy

Occupancy specification from the local occupancy switch (for the function, see the table entitled «Functions Inputs Occupancy» next page).

nvoHeatOutput: SNVT_lev_percent

Control signal for heating.

nvoCoolOutput: SNVT_lev_percent

Control signal for cooling.

nvoSpaceTemp: SNVT_temp_p

Displays the room temperature of the nviSpaceTemp. If nviSpaceTemp is not linked, then the variable will display the value 0x7FFF.

nvoUnitStatus: SNVT_HVAC_Status

Displays the operating mode of the controller (in accordance with Functional Profile #8060).

nvoHeatCoolOut: SNVT_lev_percent

Depicts the heating and cooling sequence for controlling the 6-way characterised control valves (see illustration, next page). This outlet runs parallel to the nvoCoolOutput or the nvoHeatOutput, respectively.

Cooling = 33...0%

Valve closed 33...66%

Heating = 66...100%

nvoEffectSetpt: SNVT_temp_p

Shows the actual setpoint of the controller.

Functional Profile as per LONMARK®

Functions Inputs Occupancy

Occupancy specification from nviOccCmd command centre	Occupancy switch nviSenOccCmd	Room operating status	Comfort extension
OC_OCCUPIED	OC_OCCUPIED	Comfort	
	OC_UNOCCUPIED	Comfort	
	OC_NUL (default)	Comfort	
OC_STANDBY	OC_OCCUPIED	Bypass	Occupied time is extended by the amount of the bypass time (comfort time) (can be adjusted in the plug-in)
	OC_UNOCCUPIED	Pre-Comfort	
	OC_NUL (default)	Pre-Comfort	
OC_UNOCCUPIED	OC_OCCUPIED	Building Protection	
	OC_UNOCCUPIED	Building Protection	
	OC_NUL (default)	Building Protection	
OC_NUL (default)	OC_OCCUPIED	Comfort	
	OC_UNOCCUPIED	Pre-Comfort	
	OC_NUL (default)	Comfort	

Note
The function nviOccCmd has a higher priority than the function nviSenOccCmd.

Funktion nvoHeatCoolOut

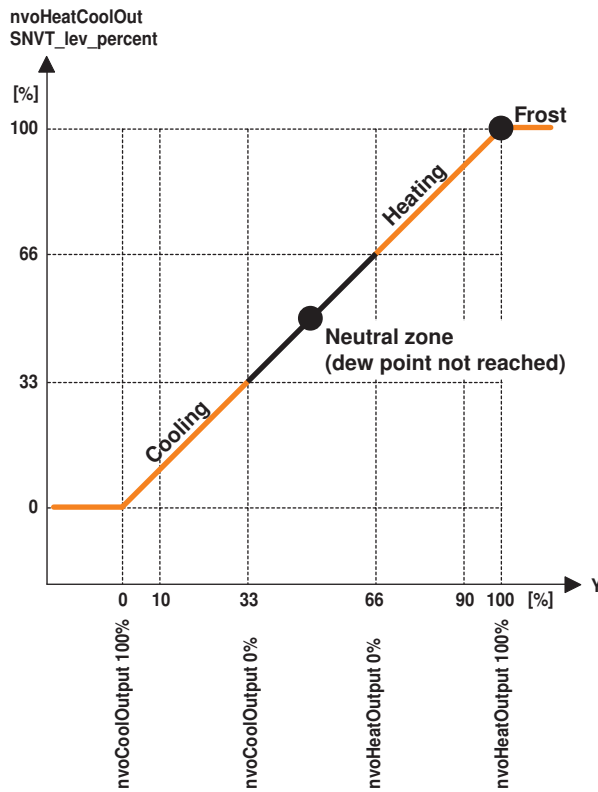

Typical application
Heating / cooling with Belimo 6-way characterised control valve.

Note chilled ceiling application
In the case of active DewPointAlarm (nviDewPointAlarm), the controller will be set to the Building Protection setpoints. The cooling sequence is deactivated.

Override control with the SNVT nviManOvr

State	Value	Actuator
HVO_OFF	–	Override control inactive
HVO_POSITION	percent	Position in % (MIN...MAX)
HVO_FLOW_VALUE	flow	–
HVO_FLOW_PERCENT	percent	–
HVO_OPEN	–	Full open
HVO_CLOSE	–	Full closed
HVO_MINIMUM	–	Minimum position
HVO_MAXIMUM	–	Maximum position

Note
The basic setting is «HVO_OFF». This value is loaded when the power supply is switched on.

Note
More detailed information on the functional profiles can be found on the website of LONMARK®. (www.lonmark.org).

Operating controls and indicators

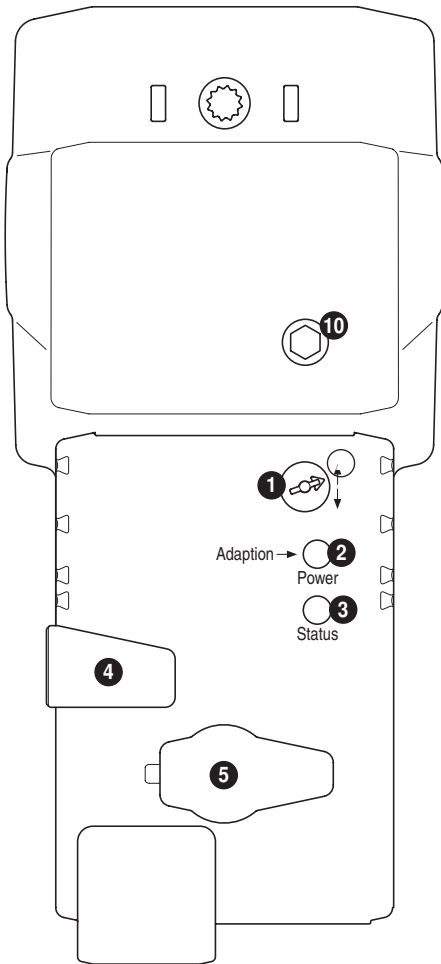

1 Direction of stroke switch

Switch over: Direction of stroke changes

2 Push-button and LED display green

Off: No power supply or malfunction

On: In operation

Press button: Triggers stroke adaptation, followed by standard mode

3 Service button for commissioning at LONWORKS® and LED display yellow for LON status

Off: The actuator is linked to the LONWORKS® and ready for operation

On: No application software is loaded in the actuator

Flashing, interval 2 s: The actuator is ready for operation, but not linked to the LONWORKS® (unconfigured)

Other flashing codes: There is a malfunction in the actuator

Press button: Service Pin Message is sent to the LONWORKS®

4 Gear disengagement button

Press button: Gear disengages, motor stops, manual override possible

Release button: Gear engages, synchronisation starts, followed by standard mode

5 Service plug

For connecting parameterisation and service tools

10 Manual override

Clockwise: Actuator spindle extends

Counterclockwise: Actuator spindle retracts

Service



Notes

- The actuator can be parameterised by PC-Tool and ZTH EU via the service socket.

Service Tools connection

ZTH EU connection

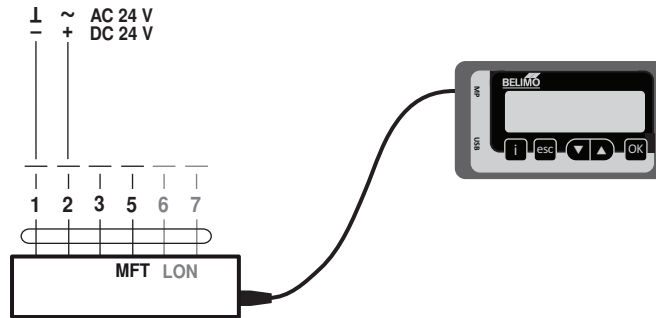

PC-Tool connection

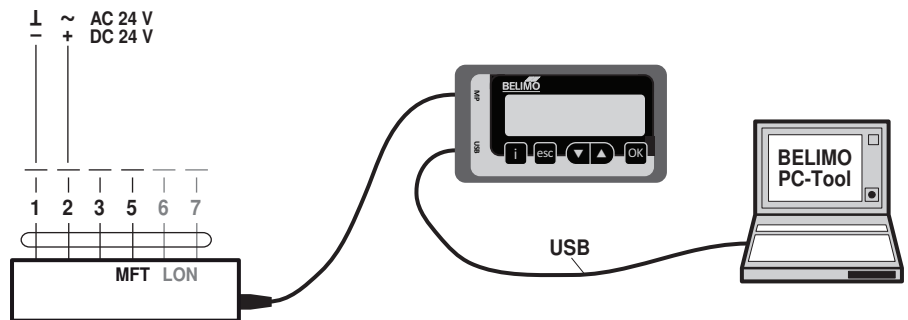

Dimensions [mm]

Dimensional drawings

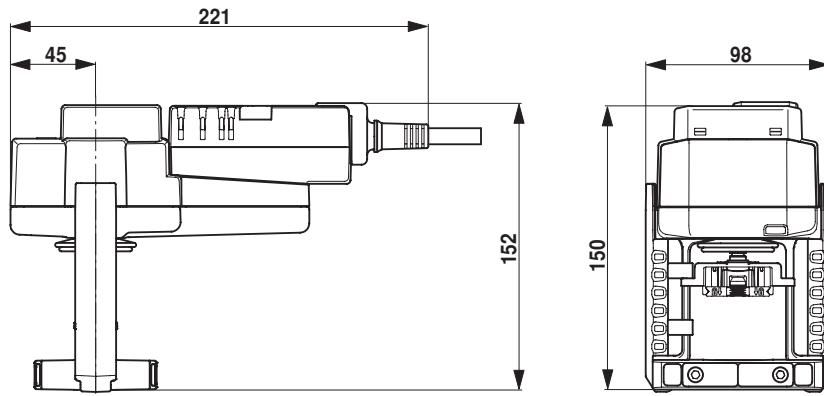

Further documentation

- Applications with integrated temp. controller
- LON actuators with CO₂ control
- Actuator Plug-in description
- Sensor Plug-in description
- Controller Plug-in description
- Tool connections
- LonWorks® Glossary